

X-3 STANDARD, OPPORTUNITY, AND FAST CHARGERS FOR INDUSTRIAL BATTERIES INSTALLATION AND OPERATING INSTRUCTIONS

**CAUTION - READ THE ENTIRE INSTALLATION AND OPERATING INSTRUCTIONS
BEFORE PLACING BATTERIES IN SERVICE**

NOTE

This document is based on information available at the time of its publication. While efforts have been made to be accurate, the information contained herein does not purport to cover all details or variations in hardware or software, nor to provide for every possible contingency in connection with installation, operation, or maintenance. Features may be described herein which are not present in all systems.

TABLE OF CONTENTS

X-3 Features and Benefits	2
Technical Specifications	3
Chassis Model Numbers	6
Charger Configuration Label	6
Safety Precautions	7
Installation Schemes	9
Installation	10
Connection to Main Power	14
Lithium-ion Battery Charging	16
Battery Communications	16
Connector and Battery Module Compatibility	16
Operating Instructions	18
Charge Modes	20
Viewing Charger Information	21
USB	23
Service and Troubleshooting	23
Index	28

X-3 FEATURES AND BENEFITS

The X-3 charger is a multi-voltage modular design for industrial battery fleet applications and is offered in 3, 6, and 10 bay cabinet sizes.. It uses Silicon Carbide MOSFET (Metal Oxide Semiconductor Field-Effect Transistor) power technology to provide efficient high frequency power conversion to minimize infrastructure costs, reduce your carbon footprint and provide multi-shift standard, opportunity and fast charging capabilities.

FEATURES*	BENEFITS
Charging capabilities	Capable of Opportunity and Fast charging (user programmable) in extended temperature industrial environments with auto finish and equalization.
Modular and stackable design	Advanced 24/36/48/72/80V Multi-Voltage Modular design allows the charger to grow with your fleet. If more power is needed, more modules can be added. If one module fails, the others continue operation. Shelf, stand, and wall mounting options available.
Intelligent charging technology	Intelligent charging technology analyzes battery historical performance and charge data to provide a rapid and efficient recharge while maximizing battery life. The charger's diagnostic intelligence evaluates battery state and condition throughout the charging cycle.
Silicon Carbide MOSFET power	Ultra high-frequency silicon carbide (SiC) MOSFET power conversion to minimize charger size and weight, while maximizing efficiency and power factor.
Anti-Arc Technology	Proprietary active arc reduction technology that allows up to a 30% start rate without aux pins.
Fully programmable	Programmable via Wi-Fi or Bluetooth® to allow wireless client configuration. Large LCD graphics display allows for clear reading of battery and charger status
Intelligent battery module	Recognizes all battery voltages automatically with or without battery module. Entire battery history and data accessible with a Stryten PowerLogger battery module.
Wireless communications	Wireless communication via Wi-Fi or Bluetooth allows both on-site and remote client configuration, programming and data downloads using Stryten eConnect.
Battery types	Lead Acid (Flooded, VRLA, AGM, Gel), Li-Ion

*X-3 chargers are field upgradeable to all capabilities as they are developed.



M-SERIES

X-3 >>>

X-3 TECHNICAL SPECIFICATIONS - 3 BAY

X-3 - MODULAR MULTI-VOLTAGE INDUSTRIAL BATTERY CHARGERS				
3 BAY				
Model #	X324-	0303	0306	0309
Single Voltage High Efficiency Module - 24V Only	24V	70A	140A	210A
Recom. Min. DC Output Wire Size**		1/0	1/0	1/0
Max Output Power		3kW	6kW	9kW
Model #	X3MV48-	0303	0306	0309
Multi-Voltage Module (24-48)	24V	64A	128A	192A
	36V	64A	128A	192A
	48V	54A	109A	163A
Recom. Min. DC Output Wire Size**		1/0	1/0	1/0
Max Output Power		3kW	6kW	9kW
Model #	X3MV80-	0303	0306	0309
Multi-Voltage Module (72-80)***	72V	39A	77A	116A
	80V	35A	70A	104A
Recom. Min. DC Output Wire Size**		1/0	1/0	1/0
Max Output Power		3.2kW	6.4kW	9.6kW
Number of Modules		1	2	3
Input Amps at 480VAC		4.2	8.3	12.5
Dimensions (HxWxD)	18.2"Hx20.6"Wx14.7"D			
Weight	50 lbs + (#Modules*9lbs)			
Input Voltage	480VAC +/-10% 3PH 60Hz			
Eff. & Power Factor	Efficiency=0.94 / Power Factor=0.95 max.			
Control	Manual and fully automatic control of charge, finish, and equalization			
Environmental	0° to 45°C (32° to 113° F), NEMA 1			
Display	4.3" Backlit Color Graphic			
Power Device	Silicon Carbide MOSFET			
AC Line Disconnect	Contactor (CEC 6 and 10 bay models)			
Certifications	CSA Certified to UL1564, CSA C22.2, CEC*			
IoT Data Capability	Wireless configuration, communication and control capabilities via BT®, Wi-Fi & PLC, USB Port			
Field Repair	Module Replacement			
Warranty	3 Year Limited Warranty			
Installation	Wall, Stand, or Shelf Mounting Options			

**Stated output currents require single or dual connectors and electrical cables of adequate rated capacity-consult your Stryten representative

***72/80V Modules are DC output rated up to 40A but are limited to 3.2kW. Therefore the average max output for 80V lead acid batteries is 35A and 80V Li-Ion Batteries is 38A

* Stated output currents will require connectors and electrical cables of adequate capacity. Consult your factory representative.

**CEC Certification pending



M-SERIES

X-3 >>>

X-3 TECHNICAL SPECIFICATIONS - 6 BAY

X-3 - MODULAR MULTI-VOLTAGE INDUSTRIAL BATTERY CHARGERS							
6 BAY							
Model #	X324-	0603	0606	0609	0612	0615	0618
Single Voltage High Efficiency Module - 24V Only	24V	70A	140A	210A	280A	350A	420A
Recom. Min. DC Output Wire Size**		1/0	1/0	1/0	3/0	4/0	250mcm
Max Output Power		3kW	6kW	9kW	12kW	15kW	18kW
Model #	X3MV48-	0603	0606	0609	0612	0615	0618
Multi-Voltage Module (24-48)	24V	64A	128A	192A	256A	320A	384A
	36V	64A	128A	192A	256A	320A	384A
	48V	54A	109A	163A	217A	272A	326A
Recom. Min. DC Output Wire Size**		1/0	1/0	1/0	3/0	4/0	4/0
Max Output Power		3kW	6kW	9kW	12kW	15kW	18kW
Model #	X3MV80-	0603	0606	0609	0612	0615	0618
Multi-Voltage Module (72-80)***	72V	39A	77A	116A	155A	193A	232A
	80V	35A	70A	104A	139A	174A	209A
Recom. Min. DC Output Wire Size**		1/0	1/0	1/0	1/0	1/0	3/0
Max Output Power		3.2kW	6.4kW	9.6kW	12.8kW	16kW	18.2kW
Number of Modules		1	2	3	4	5	6
Input Amps at 480VAC		4.2	8.3	12.5	16.6	20.8	24.9
Dimensions (HxWxD)	27"Hx18.6"Wx14.5"D						
Weight	67 lbs + (#Modules*9lbs)						
Input Voltage	480VAC +/-10% 3PH 60Hz						
Eff. & Power Factor	Efficiency=0.94 / Power Factor=0.95 max.						
Control	Manual and fully automatic control of charge, finish, and equalization						
Environmental	0° to +40°C (32° to 122° F), NEMA 1						
Display	4.3" Backlit Color Graphic						
Power Device	Silicon Carbide MOSFET						
AC Line Disconnect	Contactor (CEC 6 and 10 bay models)						
Certifications	CSA Certified to UL1564, CSA C22.2, CEC*						
IoT Data Capability	Wireless configuration, communication and control capabilities via BT®, Wi-Fi & PLC, USB Port						
Field Repair	Module Replacement						
Warranty	3 Year Limited Warranty						
Installation	Wall, Stand, or Shelf Mounting Options						

**Stated output currents require single or dual connectors and electrical cables of adequate rated capacity-consult your Stryten representative

***72/80V Modules are DC output rated up to 40A but are limited to 3.2kW. Therefore the average max output for 80V lead acid batteries is 35A and 80V Li-Ion Batteries is 38A

* Stated output currents will require connectors and electrical cables of adequate capacity. Consult your factory representative.

**CEC Certification pending



M-SERIES

X-3 >>>

X-3 TECHNICAL SPECIFICATIONS - 10 BAY

X-3 - MODULAR MULTI-VOLTAGE INDUSTRIAL BATTERY CHARGERS					
10 BAY					
Model #	X324-	1021	1024	1027	1030
Single Voltage High Efficiency Module - 24V Only	24V	490A	560A	630A	700A
Recom. Min. DC Output Wire Size**		4/0(Qty2)	4/0(Qty2)	4/0(Qty2)	4/0(Qty2)
Max Output Power		21kW	24kW	27kW	30kW
Model #	X3MV48-	1021	1024	1027	1030
Multi-Voltage Module (24-48)	24V	448A	512A	576A	640A
	36V	448A	512A	576A	640A
	48V	380A	435A	489A	543A
Recom. Min. DC Output Wire Size**		4/0(Qty2)	4/0(Qty2)	4/0(Qty2)	4/0(Qty2)
Max Output Power		21kW	24kW	27kW	30kW
Model #	X3MV80-	1021	1024	1027	1030
Multi-Voltage Module (72-80)***	72V	271A	309A	348A	386A
	80V	243A	278A	314A	348A
Recom. Min. DC Output Wire Size**		3/0	4/0	4/0	250mcm
Max Output Power		21.4kW	24.6kW	27.8kW	31kW
Number of Modules		7	8	9	10
Input Amps at 480VAC		29.1	33.2	37.4	41.5
Dimensions (HxWxD)		39.5"Hx18.6"Wx14.5"D			
Weight		105 lbs + (#Modules*9lbs)			
Input Voltage		480VAC +/-10% 3PH 60Hz			
Eff. & Power Factor		Efficiency=0.94 / Power Factor=0.95 max.			
Control		Manual and fully automatic control of charge, finish, and equalization			
Environmental		0° to +40°C (32° to 122° F), NEMA 1			
Display		4.3" Backlit Color Graphic			
Power Device		Silicon Carbide MOSFET			
AC Line Disconnect		Contactor (CEC 6 and 10 bay models)			
Certifications		CSA Certified to UL1564, CSA C22.2, CEC*			
IoT Data Capability		Wireless configuration, communication and control capabilities via BT®, Wi-Fi & PLC, USB Port			
Field Repair		Module Replacement			
Warranty		3 Year Limited Warranty			
Installation		Wall, Stand, or Shelf Mounting Options			

**Stated output currents require single or dual connectors and electrical cables of adequate rated capacity-consult your Stryten representative
 ***72/80V Modules are DC output rated up to 40A but are limited to 3.2kW. Therefore the average max output for 80V lead acid batteries is 35A and 80V Li-Ion Batteries is 38A

* Stated output currents will require connectors and electrical cables of adequate capacity. Consult your factory representative.
 **CEC Certification pending

CHASSIS MODEL NUMBERS



Each charger has a chassis model number located on the charger’s data sticker. The data sticker can be found on the back of the charger.

Examples for each type of cabinet size are shown below:





BATTERY CHARGER – MODULAR, HIGH FREQUENCY
 Model : CS9000 US
 Input Voltage : 480V~ 3PH / 50–60Hz
 Max. AC Input Current*: 14.4A
 Max. No of Modules*: 3
 DC Output Voltage*: 24/36/48/72/80V
 Max. DC Output Current*: 210/192/163/116/104A
 Max. Battery AH: 1315/1200/1020/725/650AH
 Battery Types: L–A, Li–Ion
 Number L–A Cells: 12/18/24/36/40
 Number Li–Ion Cells**: Refer to user manual
 * Values are configuration dependent. Refer to user manual for value specific configuration
 ** Always refer to charger user manual and battery manufacturer to ensure compatibility.
 For installation and user instructions see www.stryten.com

SER NO: YYWWXXXXXX

 EOEXXXXXXX
 DATE CODE: YYWW MADE IN SLOVAKIA





BATTERY CHARGER – MODULAR, HIGH FREQUENCY
 Model : CS18000 US
 Input Voltage : 480V~ 3PH / 50–60Hz
 Max. AC Input Current*: 28.8A
 Max. No of Modules*: 6
 DC Output Voltage*: 24/36/48/72/80V
 Max. DC Output Current*: 420/384/326/232/209A
 Max. Battery AH: 2000/2000/2000/1450/1310AH
 Battery Types: L–A, Li–Ion
 Number L–A Cells: 12/18/24/36/40
 Number Li–Ion Cells**: Refer to user manual
 * Values are configuration dependent. Refer to user manual for value specific configuration
 ** Always refer to charger user manual and battery manufacturer to ensure compatibility.
 For installation and user instructions see www.stryten.com

SER NO: YYWWXXXXXX

 EOEXXXXXXX
 DATE CODE: YYWW MADE IN SLOVAKIA

BATTERY CHARGER – MODULAR, HIGH FREQUENCY
 Model : CS30000 US
 Input Voltage : 480V~ 3PH / 50–60Hz
 Max. AC Input Current*: 48A
 Max. No of Modules*: 10
 DC Output Voltage*: 24/36/48/72/80V
 Max. DC Output Current*: 700/640/543/386/348A
 Max. Battery AH: 2000/2000/2000/2000/2000AH
 Battery Types: L–A, Li–Ion
 Number L–A Cells: 12/18/24/36/40
 Number Li–Ion Cells**: Refer to user manual
 * Values are configuration dependent. Refer to user manual for value specific configuration
 ** Always refer to charger user manual and battery manufacturer to ensure compatibility.
 For installation and user instructions see www.stryten.com

SER NO: YYWWXXXXXX

 EOEXXXXXXX
 DATE CODE: YYWW MADE IN SLOVAKIA



CHARGER CONFIGURATION LABEL

Each charger has a configuration label located on the backside of the charger. The label contains the configuration model number, which is defined by the model numbering scheme in the X-3 Technical Specification table. This label also shows the CEC (California Energy Commission) compliance trademark.



Factory Charger Configuration

Model NO: X3MV48- 0618
Installed Modules: 6
AC Amps In: 24.9 A
DC Volts Out: 24/36/48 VDC
DC Amps Out: 384/384/326 A

For Installation and user instructions see www.stryten.com/us/en/Furyx3



CEC Compliance Trademark

SAFETY PRECAUTIONS

SAVE THESE INSTRUCTIONS. This manual contains important safety and operating instructions.



This danger symbol indicates that personnel must practice safety procedures to prevent equipment damage, bodily injury, or death.



CAUTION! BATTERIES CAN BE DANGEROUS.

Batteries generate explosive gases during normal charging and usage. Do not smoke, use open flame or cause sparking near the battery. To reduce risk of battery explosion always follow charging instructions and those of the battery manufacturer.



WARNING! DO NOT ATTEMPT TO CHARGE NON-RECHARGEABLE BATTERIES.

Fast chargers are designated to be used only for charging rechargeable batteries. Attempting to charge a non-rechargeable battery could lead to possible injury or death from exploding batteries.



WARNING! RISK OF ELECTRICAL SHOCK THAT CAN CAUSE SERIOUS INJURY OR DEATH.

Do not touch un-insulated battery terminals, connectors or other live electrical parts. Always make sure the charger is OFF before disconnecting it from the battery. Disconnect the charger from input power and battery before servicing. Only qualified personnel should install, use, or service the charger.



CAUTION! NEVER PLACE THE CHARGER DIRECTLY ABOVE OR BELOW THE BATTERY BEING CHARGED.

Never place the charger directly above or below the battery being charged; gases or fluids from the battery will corrode and damage the charger. Locate the charger as far away from the battery as DC cables permit.

PRÉCAUTIONS DE SÉCURITÉ

CONSERVER CES INSTRUCTIONS. Ce manuel comporte des consignes importantes de sécurité et d'utilisation.:



Ce symbol de danger indique que le personnel doit suivre les procédures de sécurité de façon à prévenir une dégradation de l'équipement, les dommages corporels ou la mort.



ATTENTION! LES BATTERIES PEUVENT ÊTRE DANGEREUSES.

Les batteries génèrent des gaz explosifs lors de leur chargement et leur utilisation habituels. Ne pas fumer, utiliser de flamme nue ou provoquer d'étincelles à proximité de la batterie. Afin de réduire le risque d'explosion de la batterie, toujours suivre les instructions lors de la mise en charge et celles du fabricant de la batterie.



WARNING! NE PAS ESSAYER DE CHARGER DES BATTERIES NON-RECHARGEABLES.

Les chargeurs rapides Express sont conçus pour être utilisés uniquement pour charger des batteries plomb-acide noyées rechargeables. Essayer de charger une batterie nonrechargeable peut mener à l'explosion des batteries et donc à des blessures ou la mort.



WARNING! RISQUE DE CHOC ÉLECTRIQUE QUI PEUT CAUSER DE GRAVES BLESSURES OU LA MORT.

Ne pas toucher les bornes non-isolées des batteries, les connecteurs ou d'autres composants électriques sous tension. Toujours s'assurer que le chargeur est éteint avant de le déconnecter de la batterie. Déconnecter le chargeur de la prise et de la batterie avant d'en assurer la maintenance. Seul du personnel qualifié doit installer, utiliser ou d'assurer la maintenance du chargeur.



ATTENTION! NE JAMAIS PLACER LE CHARGEUR DIRECTEMENT AU-DESSUS OU AU-DESSOUS DE LA BATTERIE EN CHARGE.

Ne jamais placer le chargeur directement au-dessus ou au-dessous de la batterie en charge; les gaz et les fluides de la batterie corroderaient et endommageraient le chargeur. Placer le chargeur aussi loin de la batterie que le permettent les câbles CC.

INSTALLATION SCHEMES

Due to the side-to-side airflow design of the X-3 charger, adequate spacing between chargers or other arrangements are required for proper operation. The following diagrams show possible placement options for multi-charger installations:

**STANDARD SIDE-TO-SIDE**

The minimum side-to-side spacing of chargers is 18 inches (46cm) for standard installations.

**SIDE-TO-SIDE WITH DIVIDERS**

Metal panels can be placed between chargers for closer spacing. Please consult factory for divider installations. The minimum charger-to-divider spacing is 4 inches (10cm).

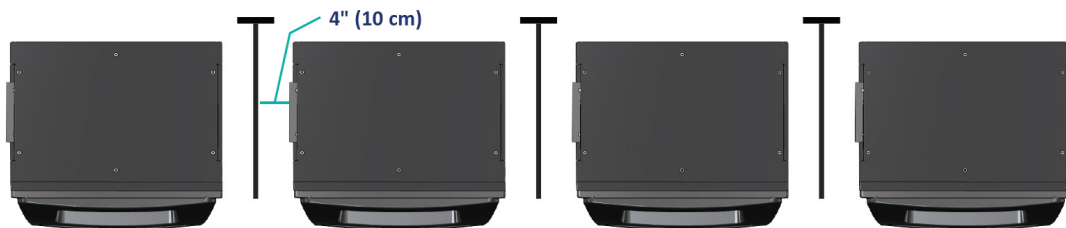
**OFFSET (45° ANGLE)**

Chargers may also be installed at a 45° offset for higher density installations.



INSTALLATION

- Installation must only be carried out by suitably qualified personnel and in accordance with current local and national wiring regulations.
- Battery leads should not be altered without prior consultation with service personnel.
- The charger should be sited in a cool, dry, well-ventilated location away from corrosive fumes and humid atmospheres. Ambient temperature range must be maintained between 32°F-104°F.
- Ensure ventilation is not obstructed at the left air intake and right exhaust vents.
- The charger is for indoor use only.
- Before installation, check that the charger has not sustained any damages during transit. Make sure the electrical ratings are suitable for both the intended AC input supply and the DC output current and voltage for the batteries to be charged. Also ensure that the connector polarity is correct and matches the polarity of the battery connector.
- CAUTION – To reduce the risk of fire, use only on circuits provided with branch circuit protection consistent with the current indicated on the Factory Charger Configuration label and in accordance with the National Electrical Code, ANSI/NFPA 70 or equivalent.
- The circuit breakers rating should be based on the charger’s maximum input current, as stated on the Factory Charger Configuration label. (See the Technical Specifications pages for more details)

WALL MOUNT INSTALLATION

Wall mounting hangers with a pogo are available for installation. Figure 1 illustrates the various parts for a typical wall mount charger installation:



Fig. 1 Wall Mounting Parts and Wall Mount with Charger

STEP 1. BOLT THE WALL MOUNT HANGER TO THE WALL

Secure the wall mount hanger to the concrete wall through the pre-drilled holes in the hanger. Ensure the two fins are facing up. Mount to a solid concrete wall through holes using bolts into wall anchors – check with professional installation personnel to determine proper mounting techniques for all wall types.



Fig. 2 Wall Mount Hanger (Proper Orientation)

STEP 2. HANG THE CHARGER ON THE WALL MOUNT

Hang the charger on the wall mount hanger so that the two slits on the back of the charger line up with the two fins of the hanger.

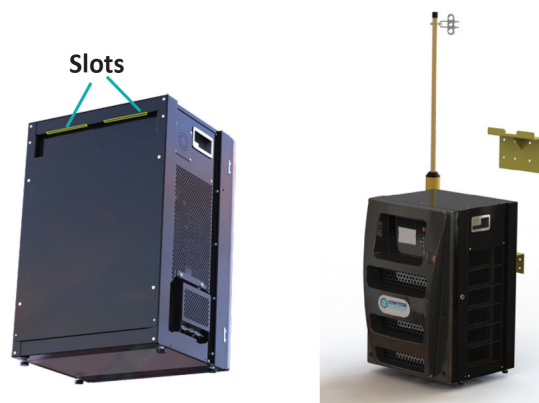

Fig. 3 Hang charger on wall mount hanger using the slots located on the back of charger

STEP 3. MOUNT THE BOTTOM BRACE TO THE CHARGER AND WALL

Fig. 4 Bottom Brace for Wall Installation

STEP 4. MOUNT THE POGO WALL BRACKET TO THE WALL AND ATTACH THE POGO

Secure the pogo wall bracket to the concrete wall using bolts paired with wall anchors – check with professional installation personnel to determine proper mounting techniques for all wall types. Attach the pogo to the wall bracket using the nut provided with the pogo.

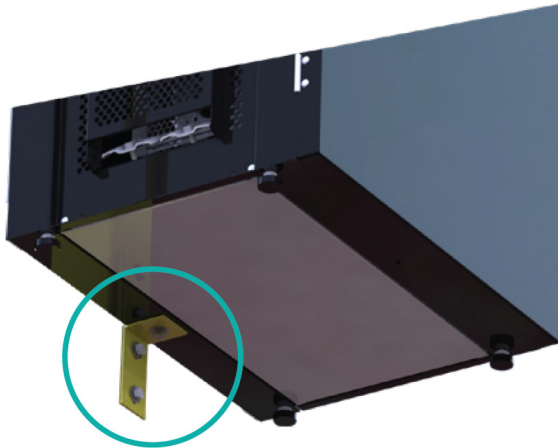

Fig. 5 Wall Mount Pogo Installation

FLOOR STAND INSTALLATION

Floor stands with a pogo are also available for installation.



Fig. 6 Floor Stand and Floor Stand with Charger

STEP 1. BOLT STAND TO THE FLOOR

Secure the stand to the concrete floor through the pre-drilled holes in the stand base. Use ½ inch diameter anchor bolts as a minimum.

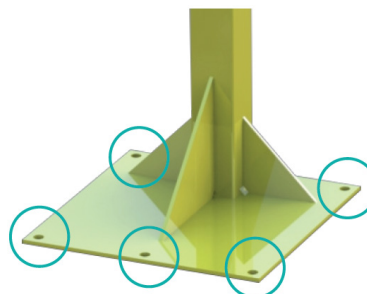

Fig. 7 Pre-drilled holes for bolting base to floor

STEP 2. ATTACH POGO TO THE POGO BRACKET

Attach the pogo to the pogo bracket with the bolts provided.

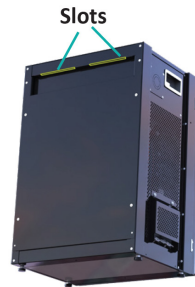

Fig. 9 Hang charger on floor stand hanger using the slots located on the back of the charger



Fig. 10 Bottom Brace for Stand Installation

STEP 3. HANG THE CHARGER ON THE STAND

Hang the charger on the floor mount hanger so that the two slits on the back of the charger line up with the two fins of the hanger.



Fig. 8 Pogo mounted on stand

STEP 4. MOUNT THE BOTTOM BRACE TO THE CHARGER AND STAND

Position the bottom brace so that it sits flush against the stand and aligns with the pre-drilled hole located on the bottom of the charger. First, attach the brace to the charger and then secure the brace to the stand using the provided bolts.

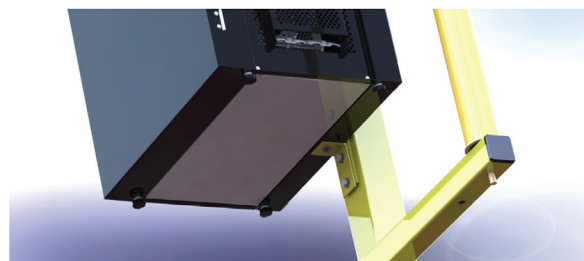

SHELF MOUNT INSTALLATION

Chargers can be mounted to a shelf using M8 bolts. Please refer to the diagrams for appropriate hole spacing for each model.

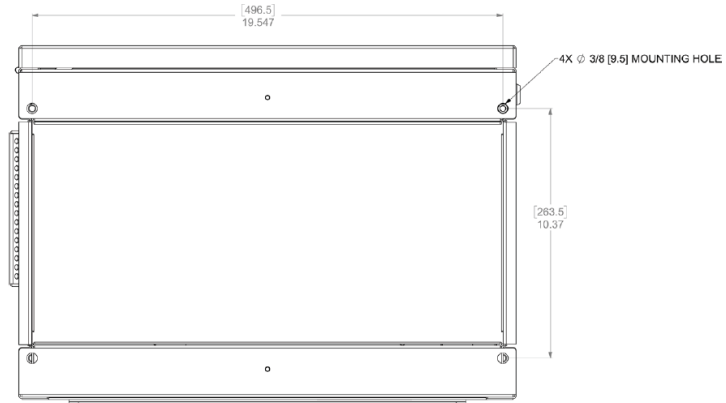
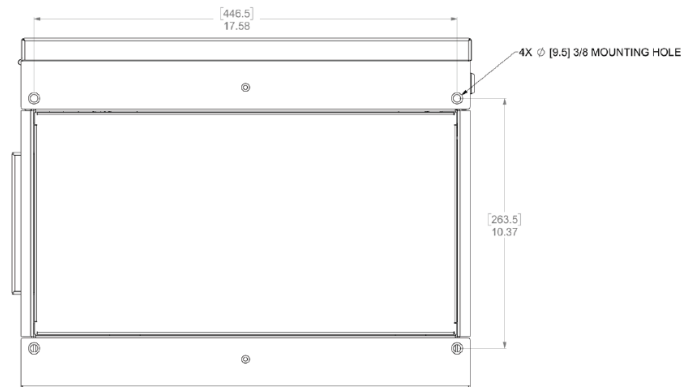
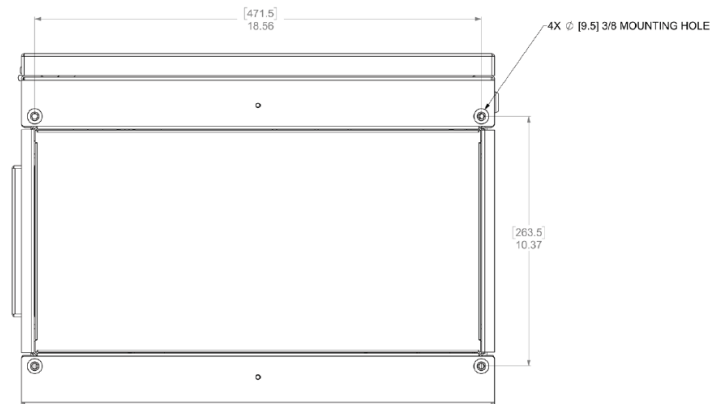
 BOTTOM VIEW
 3 BAY

 BOTTOM VIEW
 6 BAY

 BOTTOM VIEW
 10 BAY

CONNECTION TO MAIN POWER



CAUTION!

Electrical connections are to be made by a qualified electrician only! Make sure that the service AC input voltage is OFF before wiring charger.

Risk of Fire! Use on circuits provided with the following branch circuit protection in accordance with your regional electric code. (National Electrical Code, NFPA 70 or IEC)

VAC Input
480VAC or 400 VAC

**Ensure the AC wiring and AC plugs used meet regional requirements. Refer to the technical specification section of this manual to view AC input information.

STEP 1. REMOVE TOP PANEL OF CHARGER

Remove the top panel of the charger by removing the six screws shown:



STEP 2. ATTACH SHIELDED INPUT CABLE OR CONDUIT TO CHARGER

Use an NEC or IEC-approved conduit or AC input cable (such as type SOOW) to connect to the charger.

Use appropriate minimum wire size or larger for maximum kilowatt rating of charger – See Technical Specification Tables: Min. AC Input Wire Size (AWG or mm²). The hole located in the top left corner of the charger must be used for the AC service entrance. Place an appropriate cable or conduit clamp in this AC service entrance hole.

AC Service Entrance Hole

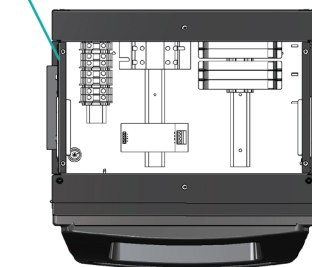

STEP 3. CONNECT 3-PHASE AC INPUT POWER CABLES

Ensure ground and power cables have been properly stripped (approximately a half inch of insulation from the ends). Loosen the securing screws in the AC input block and insert the stripped ends of the ground and power cables. Retighten the screws. The 3-phase input is not phase specific, so AC line input positions are interchangeable. Ensure cable or conduit clamp has been properly tightened.

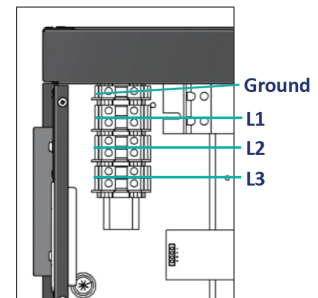

STEP 4. CONNECT DC OUTPUT POWER CABLES

Use an NEC or IEC-approved DC output cable (if not already equipped from the factory) such as type UL 3311, UL 3279, or CSA CL 905 –battery cable, with a polarized connector appropriate for battery charging (such as REMA MRC 80, 160, 320, REMA DIN 640, or Anderson Power Products Euro, SBX, or SB connectors).

Use appropriate minimum wire size or larger for maximum kilowatt rating of charger – See Technical Specification Table: Min. DC Output Wire Size (AWG or mm²).

The panel located at the bottom left of the charger must be used for the DC power output cables. There are threaded studs for the attachment of cable terminals which must be crimped or soldered to the DC cable. The positive (red) cable is attached on the right and the negative (black) cable is attached on the left. The clamps(s) at bottom are provided to secure the DC output cables.



EXAMPLE CABLE: COBRA BRAND BATTERY CABLE CHART

Cobra Part Number	Size (AWG)	Stranding	Insulation Thickness (in)	Nominal OD (in)	UL Style	CSA	Amps		Cable Weight (lbs/MFT)
							*90°C	**105°C	
C9908B	8	133 x 29	0.060	0.29	UL 3311 & UL 3279	CL 905	83	92	84
C9906B	6	259 x 30	0.080	0.375	UL 3311 & UL 3279	CL 905	105	118	136
C9904B	4	420 x 30	0.080	0.43	UL 3311 & UL 3279	CL 905	140	157	189
C9902B	2	665 x 30	0.080	0.495	UL 3311 & UL 3279	CL 905	190	213	288
C9901B	1	836 x 30	0.095	0.565	UL 3311 & UL 3279	CL 905	220	246	348
C9910B	1/0	1064 x 30	0.095	0.615	UL 3311 & UL 3279	CL 905	260	291	444
C9920B	2/0	1330 x 30	0.095	0.664	UL 3311 & UL 3279	CL 905	300	336	551
C9930B	3/0	1672 x 30	0.095	0.719	UL 3311 & UL 3279	CL 905	350	392	663
C9940B	4/0	2109 x 30	0.095	0.785	UL 3311 & UL 3279	CL 905	405	454	820
C4925B	250 MCM	2451 x 30	0.095	0.806	UL 3311 only	CL 905	455	510	970

*Allowable Ampacities of Single Insulated Conductors, per NEC table 310-17 Cable manufactured in accordance with Federal EPA Rule, Title 40-part 82, (ODC's)

**The 105°C cable ampacities are adapted from ICEA P-54-440/NEMA WC51- 1986(R1991). The ampacities are provided for informational purposes only. Acceptance of these values by any governing authority is the responsibility of the end user. Ampacities are based on a single conductor, in free air, at 30°C ambient air temperature.

MAXIMUM CURRENT CARRYING CAPACITIES FOR CABLE AND CONNECTOR COMBINATIONS

Connectors	Cable Sizes			
	1/0 AWG	3/0 AWG	4/0 AWG	250mcm
SB175	230A	N/A	N/A	N/A
SB350	N/A	280A	350	380
Euro320				N/A
SBX350				350
REMA640				380
REMA320			N/A	N/A

NOTE: Many of the mm² wire sizes are based on calculations. See the catalog for specific mm² wire sizes.

LITHIUM ION BATTERY CHARGING

The X-3 charger is capable of charging Stryten Energy 24V/36V/48V/72V/80V lithium ion batteries. All lithium batteries charged with the X-3 require an approved Battery Management System (BMS), CAN communications, X-Loop disconnect sensing, and a recognized charging protocol. Please consult with an authorized Stryten representative before using the X-3 to charge lithium batteries other than Stryten Energy brand to ensure absolute compatibility.

BATTERY COMMUNICATIONS

The X-3 charger supports several communication interfaces for opportunity and fast charging of almost any motive power battery including lithium ion. The following shows information on the different communication options:

Note: Lead acid batteries may be charged without a battery module or X-Loop up to 20% of the battery's nameplate capacity, however, battery data is not available without a module.

PL3 BATTERY MODULE (RS-232)

A PL3 battery module collects temperature, electrolyte level, and state of charge data from the battery and sends it to the charger. Temperature data allows for fast charging, thus reducing the time for a battery to reach full charge. This is the recommended setup for charging lead acid batteries.

Battery Type	Lead Acid
Recommended Connector Type(s)	Anderson SBX /Euro or REMA 320/640
Charge Rate	Up to 40% of battery's nameplate capacity
Battery Data	Yes
Anti-Arc Protection	Yes, both connector separation and integral module anti-arc sensing

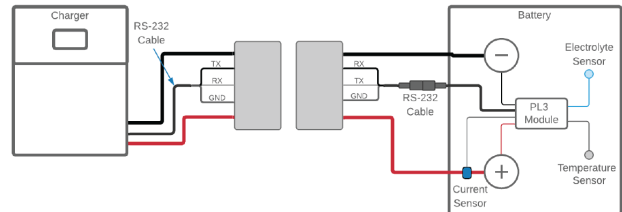

PLC BATTERY MODULE (POWER LINE COMMUNICATION)

A PLC battery module communicates over main power cables to establish a wireless Bluetooth connection allowing charger/battery communications without auxiliary wiring. Battery temperature, electrolyte level, and state of charge are transmitted to the charger allowing for higher charge rates than standard rate (no module) charging.

Battery Type	Lead Acid
Recommended Connector Type(s)	Anderson SB Series
Charge Rate	Up to 30% of battery's nameplate capacity
Battery Data	Yes
Anti-Arc Protection	Integral module anti-arc sensing only

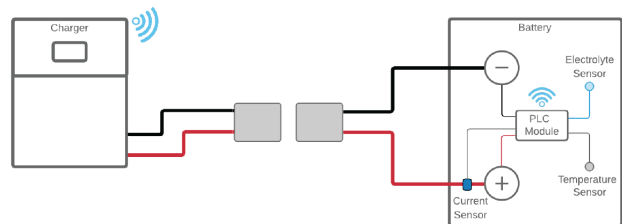

X-LOOP

X-Loop disconnect sensing uses a current sense loopback auxiliary contact wiring for sensing battery disconnect. X-Loop provides anti-arc protection for hot disconnects while charging. Since battery temperature data is not available with X-loop, charging will be limited to standard rate.

Battery Type	Lead Acid
Recommended Connector Type(s)	Anderson SBX /Euro or REMA 320/640
Charge Rate	Up to 20% of battery's nameplate capacity
Battery Data	No
Anti-Arc Protection	Yes, both connector separation and integral module anti-arc sensing

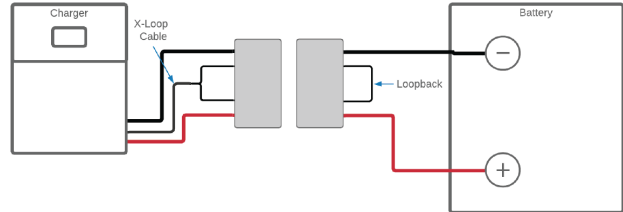

CAN BUS (LI-ION)

When charging a Li-ion battery, a Battery Management System (BMS) communicates with the charger using a CAN bus. The charger will recognize connector separation using X-Loop disconnect sensing. CAN bus communication is required for lithium-ion battery charging.

Battery Type	Li-ion
Recommended Connector Type(s)	Anderson SBX /Euro or REMA 320/640
Charge Rate	Up to 100% of battery's nameplate capacity
Battery Data	Yes
Anti-Arc Protection	Yes, both connector separation and integral module anti-arc sensing

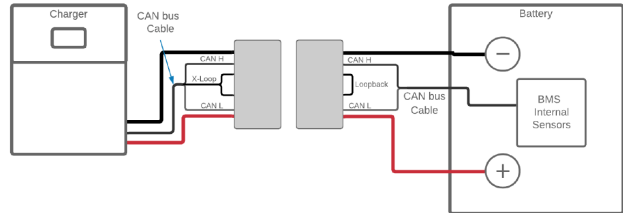

	Conventional Charging		Opportunity/Fast Charging		Li-ion Charging
	No Accessory	X-Loop	PL-3 Module	PLC Module	CAN bus
Euro/REMA Connectors	Not recommended*	●	●	✘	●
SB Connectors	●	✘	✘	●	✘
SBX Connectors	●	●	●	●	✘

***WARNING:** Using Euro/REMA connectors without disconnect sensing contacts may result in premature connector failure. Stryten strongly recommends using auxiliary contacts (X-Loop or PL3) in the Euro/REMA connectors to sense battery/charger disconnects and prevent arcing that causes premature connector failure. The factory will provide auxiliary contacts at no charge for all Euro/REMA installations.

OPERATING INSTRUCTIONS

CONTROL PANEL FEATURES

1. 4.3" Backlit Color Graphic Display
2. USB Port for Updates and Data Transfer
3. Navigation Buttons
4. Start/Stop Button



CHARGER OPERATION

CONNECT BATTERY:

If a battery is not connected, the Connect Battery Screen is displayed. To start a charge cycle, attach charger cables to the battery. The charger will initialize the battery and be ready to start charging.



START CHARGING:

If a battery is connected, the Press Start Screen is displayed. Press the START/STOP button to begin charging. If AutoStart is enabled, the charger will begin charging automatically after a 10 second countdown when a battery is connected to the unit.



VIEWING CHARGING INFORMATION:

AFTER A CHARGE HAS BEEN STARTED, THE CHARGER WILL DISPLAY THE FOLLOWING INFORMATION:

1. Amp-hours Returned to Battery
2. Charge Mode (CC, CV, FN, EQ, TK)
3. SOC Progress Bar
4. Battery ID (if equipped)
5. Error Warning (When Flashing)
6. Battery Temperature (if battery module equipped)
7. Charge Voltage
8. Charge Current
9. Active Power Drawers Indicator
10. State of Charge
11. Time, Wi-Fi, and Bluetooth

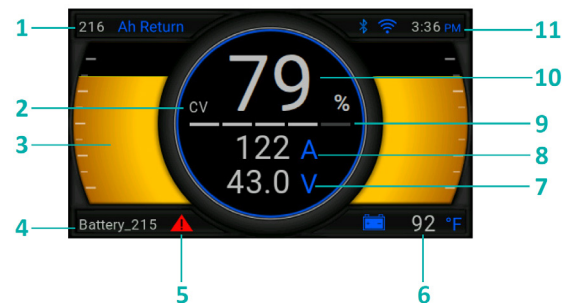

STOP CHARGING:

To stop charging, press the START/STOP button during a charge. If a charge cycle is stopped by pressing the START/STOP button, the User Stopped Screen is displayed.

Note: While charging, always press the stop button before disconnecting battery to prevent damage to the charger and battery. If the battery is disconnected during a charge cycle, the charger will stop automatically.

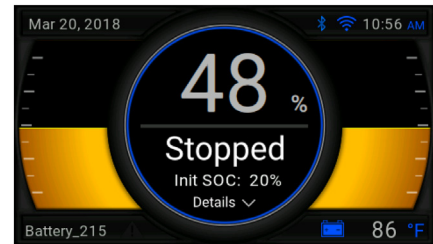
**CHARGE COMPLETE (LEAD ACID ONLY):**

When the charger completes a charge cycle, the Charge Complete Screen is displayed. The complete screen displays the battery's state of charge along with its initial state of charge. There is also the option to view charge details by pressing the down arrow. The details screen provides the same information as the record detail screen. If the battery is left connected to the charger for a consecutive 5 days after completing a charge, the charger will perform a refresh charge to ensure the battery remains at its maximum capable capacity.



CHARGE MODES

LEAD-ACID CHARGE MODES

Constant Current (CC)

The charger operates in constant current mode until the target voltage is reached. In CC mode, the current is equal to the user specified start rate which typically ranges from 10-40% of the battery's capacity.

Constant Voltage (CV)

The charger will switch over from constant current mode to constant voltage mode once the battery's target voltage has been reached. In CV mode, the charging voltage will remain constant as the current slowly decreases. Once the current decreases to a certain percentage of the battery capacity, the charger will transition to one of the following modes in order of priority: Finish mode, Mix mode, or Charge Complete.

Finish (FN)

Finish mode charges the battery at a low, constant rate of charge to achieve the battery's maximum state of charge. Finish mode can only occur after constant voltage mode has completed. A finish charge is typically performed no more than once per week to prevent excessive overcharging.

Equalize (EQ)

Equalize mode charges a battery at low charge rate with a high float voltage to balance or equalize the battery's cell voltages. An equalization charge can only be performed after completing a finish charge.

Mix (MX)

Mix mode is essentially a short finish. Mixing can only occur after constant voltage mode has completed and is typically performed daily.

Trickle (TK)

Trickle mode is used to charge a battery with a lower than normal voltage. When the charger detects a battery with a voltage below an expected threshold, the charger will attempt to charge the battery at a low current until the battery's voltage is suitable for constant current mode.

LITHIUM-ION CHARGE MODES

Main Charge Constant Current (CC)

The charger puts out a constant current determined by the battery's Battery Module System (BMS). Once a target voltage has been reached the BMS will transition to Equalize mode.

Equalize

Lithium Equalize mode equalizes the cell voltages until the target SOC and cell voltages are achieved across all cells.

Voltage Hold

Once a lithium battery reaches 100% SOC, the BMS will enter Voltage Hold mode. This mode maintains the battery voltage above a certain threshold to compensate for self-discharge while continuing to equalize cell voltages until reaching a "well balanced" state.

VIEWING CHARGER AND CHARGING INFORMATION

MAIN MENU

Press the center or right arrow to access the Main Menu from the idle or charging screen. All other menus are accessed from the Main Menu. Use the arrow keys to navigate and the center key to select options. Main Menu options include:

EQ – Manually select equalization to occur
(Note: If this feature is enabled, it is only accessible when a battery is connected)

Actuals – View Actuals Menu

Records – Browse charge records stored on the charger

Settings – View the Settings Menu

Info – View system information



EQ

If this menu is enabled, it allows a user to manually run equalization on the connected battery. The selected option is indicated by a checkmark. Only one option can be selected at a time. By default, the charger will follow the user defined schedule for finish and equalize. To manually begin an equalize cycle, navigate to the Main Menu and select the EQ Menu. Select the Equalize option. A check next to Equalize indicates a finish and equalize cycle will occur after the regular charge cycle.

Use Schedule – The charger will follow its programmed schedule for equalization and mixing.

Equalize – The charger will finish and equalize the currently connected battery once it's fully charged.

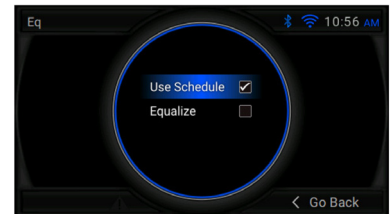

ACTUALS

This menu has options to view data for each of the power modules and battery information for a connected battery.

Controller – Displays information about the management controller.

Modules – Displays status information for each power module in the charger.

Battery – Displays information about the currently connected battery.

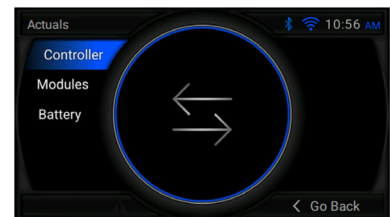

RECORDS

This menu holds records of the 100 most recent charges always starting with the most recent. Select a record by using the Up and Down arrow keys. To view a selected record details, press the center key. Use the left arrow key to go back to the previous screen.



Record #	Date	Time	Serial
1.	07/17/2018	18:09	S129763
2.	07/17/2018	18:02	S129763
3.	07/17/2018	15:00	S129763
4.	07/17/2018	13:26	S129763
5.	07/17/2018	13:13	S129763
6.	07/15/2018	01:00	S129763
7.	07/13/2018	17:19	S129763
8.	07/13/2018	16:25	S129763
9.	07/13/2018	16:11	S129763
10.	07/08/2018	01:00	S129763

RECORD DETAIL

DETAIL	INFORMATION
Timestamp	Date and time of charge event
Duration	Length in hh:mm:ss of the charge event
Battery ID	Battery name
Battery Serial	Battery serial number
Module Serial	Module or power logger serial number
Battery Info	Voltage and capacity of battery
SOC	Start and end SOC
Voltage	Start, end, and max battery voltages
Temperature	Start, end, and max battery temperatures
Amp Hours Returned	Amp hours returned to the battery
Charge Profile	Charge profile used during charge
OS/App Version	Operating system and application version numbers
Termination	Reason for event termination

SETTINGS

Settings Menu: This menu allows a user to browse current user settings for the charger.

User Settings: Displays the currently configured user settings.

Schedule: Displays the Finish/EQ, Mix, and Finish Makeup schedules.

Max Amps: Displays the max ampere settings for various battery sizes.

Set Date: Allows a user to set the date on the display.

Set Time: Allows a user to set the time on the display.

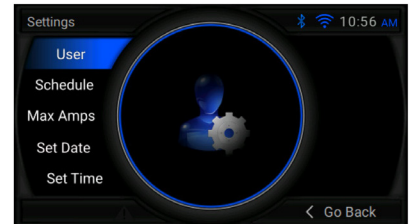

SET DATE AND TIME

From the Settings Menu, select Set Date or Set Time. Use the left and right arrows to highlight a property and the up and down arrows to change that property. Note: the Set Time menu uses a 24-hour clock. When setting the date or time backwards, the charger will reboot after 10 seconds.

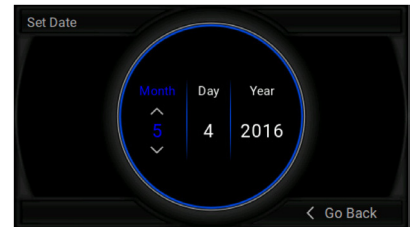

INFO (SYSTEM INFORMATION)

This screen displays the following information about the charger:

Type | Serial number | Application version | Drawer quantity |
 Kilowatt rating | Max output current | Cable configuration | Voltage setting

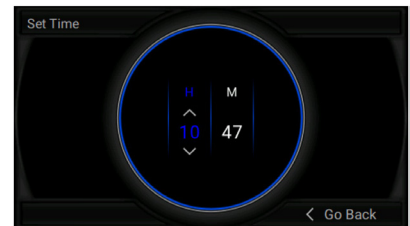

USB

DOWNLOAD CHARGE RECORDS

A charger can transfer its charge records to a USB drive. For instructions on transferring data, contact your local sales representative.

UPDATE SOFTWARE

A USB stick can be used to update the charger's software. If you need assistance with updating charger software, please contact your local sales representative.

SERVICE AND TROUBLESHOOTING

WARNING INDICATOR

If an error occurs and the charger can keep charging, the red warning symbol will flash in the bottom-left of the screen. To find out more details about the warning, press the center or right navigation button to view the Warning Details screen. You can still access the main menu by pressing the center or right navigation button again.

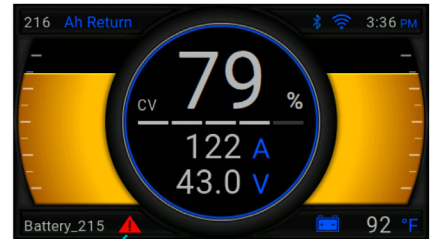

Warning Indicator

SYSTEM ERROR

If an error occurs that restricts the charger from running properly, the following screen will be displayed:

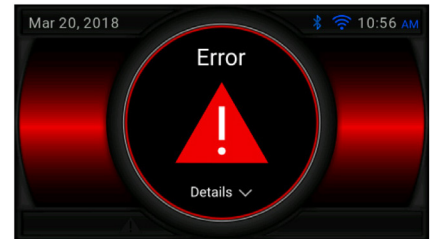

To find more information on the error, press the down arrow on the navigator to access the Error Details screen.

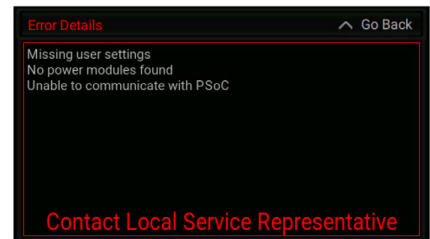

X-3 MODULE UPGRADES

Consult your local Stryten sales representative to determine an appropriate upgrade package. This will require an on-site visit from an Stryten authorized technician to assess your power and upgrade requirements.

Upgrading the X-3 with a different number of power modules requires:

1. Consultation with a Stryten authorized representative to determine your new power and configuration requirements
2. Ordering and receiving the authorized upgrade package service from Stryten
3. Upgrading of the electrical AC service to the charger (if required) by a professional electrician
4. Having a Stryten factory authorized technician install the upgrade package consisting of:
 - a. Power Module(s)
 - b. New DC output cables & connector (if required)
 - c. New charger configuration sticker (calls out new electrical requirements)
 - d. Updating of the charger's control panel factory settings

WARNING: Only Stryten factory trained and authorized technicians should upgrade your X-3 charger. Stryten is not responsible for unauthorized X-3 charger changes or upgrades.

WARNING: The number of power modules in the charger must match the module quantity on the charger's Info screen. Do not add power modules to a charger without the help of an authorized Stryten factory representative.

WARNING: Adding additional power modules to your X-3 charger may require upgrading your AC service wiring and DC output cables. Your Stryten factory authorized technician will refer to the X-3 Technical specifications page to determine if AC breaker size, AC wiring, DC output cables, and DC connectors will meet the specified requirements when installing additional power module(s).

WARNING: Electrical AC service wiring upgrades should only be performed by a licensed electrician.

POWER MODULE REPLACEMENT

IMPORTANT! Make sure the charger is completely POWERED OFF and NO BATTERY CONNECTED before opening the charger’s door and replacing a power module. Power module replacement should only be performed by qualified personnel.

Required Tools:
 Flat Head Screwdriver
 7mm Socket Wrench

STEP 1. OPEN CHARGER DOOR

Using the flat head screw driver, turn the latch on the side of the charger clockwise to unlock the door and open it.



STEP 2. DISCONNECT POWER CABLES

Disconnect the 3-phase AC input and the DC output cables from the power module you intend to replace by squeezing the clamp releases and pulling. Use a 7mm socket wrench to disconnect the ground cable.



STEP 3. DISCONNECT POWER MODULE COMMUNICATION CABLE(S)

There are two possible configurations for power module communications. Directions for disconnecting each type are shown:

SINGLE CABLE CONNECTION

For a single cable connection, start by disconnecting the end of the cable from the termination block located at the very bottom of the charger. Then, unplug the communications starting from the bottom power module until you have disconnected the module you are replacing.

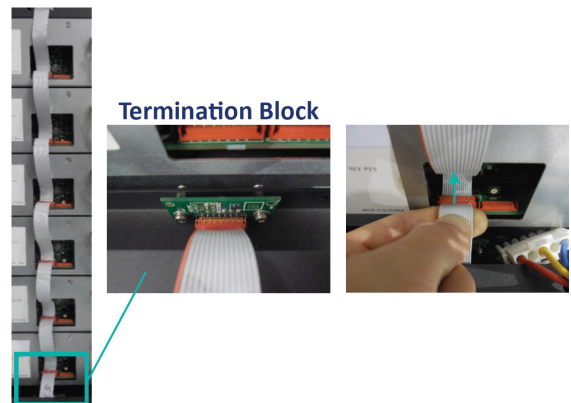

MULTI-CABLE CONNECTION

For a multi-cable connection, you only need to disconnect the communication cables from the module you are replacing.

STEP 4. LOOSEN MOUNTING SCREWS AND REMOVE POWER MODULE

Using a flat head screwdriver, turn each mounting screw counter clockwise until the spring ejects and releases the screw from the nut. Carefully pull the power module out.

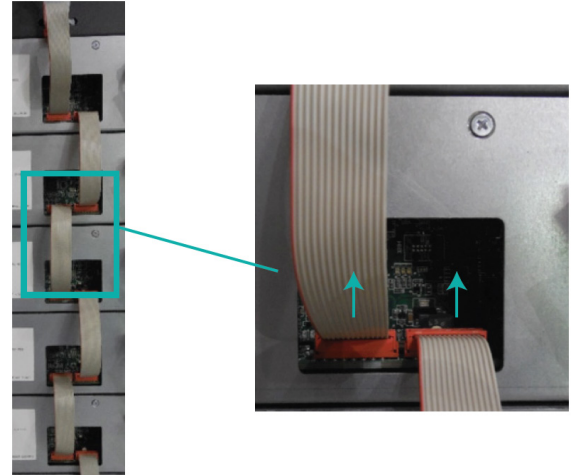

STEP 5. INSERT REPLACEMENT MODULE AND SET MODULE POSITION SELECTOR

Insert the replacement power module. Use a flat head screwdriver to tighten the mounting screws by pushing in and turning clockwise.

Using a flat head screwdriver, adjust the module position selector to match the module's position. For each charger size, the power module positions are shown in the module position tables.



3 BAY CHARGER
Module 1
Module 2
Module 3

10 BAY CHARGER
Module 1
Module 3
Module 5
Module 7
Module 9
Module 2
Module 4
Module 6
Module 8
Module 0

6 BAY CHARGER
Module 1
Module 2
Module 3
Module 4
Module 5
Module 6

Power Module Position Selector

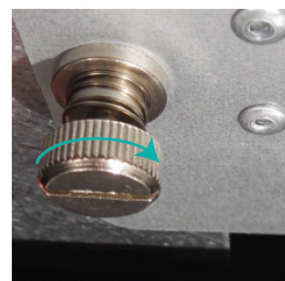
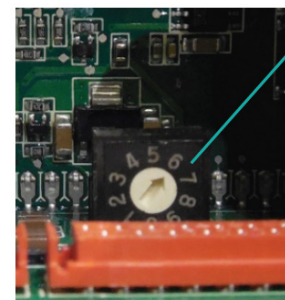

STEP 6. RECONNECT COMMUNICATION AND POWER CABLES

Reconnect all communication cables that were disconnected in step 3. Reconnect ground, DC output, and AC input cables. Close charger door and use flat head screwdriver to turn the latch counter-clockwise to lock.

POWER MODULE UPGRADE

Consult your local Stryten sales representative to determine an appropriate upgrade package. This will require an on-site visit from an Stryten authorized technician to assess your power and upgrade requirements.

Upgrading the X-3 with a different number of power modules requires:

1. Consultation with a Stryten authorized representative to determine your new power and configuration requirements
2. Ordering and receiving the authorized upgrade package service from Stryten
3. Upgrading of the electrical AC service to the charger (if required) by a professional electrician
4. Having a Stryten factory authorized technician install the upgrade package consisting of:
 - a. Power Module(s)
 - b. New DC output cables & connector (if required)
 - c. New charger configuration sticker (calls out new electrical requirements)
 - d. Updating of the charger's control panel factory settings

WARNING: Only Stryten factory trained and authorized technicians should upgrade your X-3 charger. Stryten is not responsible for unauthorized X-3 charger changes or upgrades.

WARNING: The number of power modules in the charger must match the module quantity on the charger's Info screen. Do not add power modules to a charger without the help of an authorized Stryten factory representative.

WARNING: Adding additional power modules to your X-3 charger may require upgrading your AC service wiring and DC output cables. Your Stryten factory authorized technician will refer to the X-3 Technical specifications page to determine if AC breaker size, AC wiring, DC output cables, and DC connectors will meet the specified requirements when installing additional power module(s).

WARNING: Electrical AC service wiring upgrades should only be performed by a licensed electrician.

INDEX

A

Actuals 21
Anti-Arc 2, 16, 17

B

Battery Types 2
Bluetooth 2, 16, 18

C

CAN bus 17
Connection to Main Power 14
Constant Current 20
Constant Voltage 20
Control Panel 18, 24, 27

D

Date 22
DC Output Cables 15, 24, 25, 27

E

EQ 3-5, 18, 20-22
Equalize 20, 21

F

Finish 2-5, 20-22
Floor Stand 11, 12

I

Info 18, 19, 21, 22
Installation 9-13

L

Lithium 16, 17, 20

M

Mix 20-22
Model Numbers 6
MOSFET 2-5

O

Operating Instructions 18

P

PL3 16, 17
PLC 3-5, 16-17
Power Module 21, 24-27

R

Record Details 21
Records 21, 23

S

Safety 7
Service and Troubleshooting 23
Settings 21, 22
Shelf Mount 13
Specifications 3-5
System Error 23

T

Technical Specifications 3-5
Time 18, 22
Trickle 20
Troubleshooting 20, 23

U

USB 18, 23

V

Voltage Hold 20

W

Wall Mount 10, 11
Wi-Fi 2-5, 18
Wireless 2-5, 16

X

X-Loop 16, 17